

# 电感式传感器

## 特氟龙涂层型



### 产品说明:

金属外壳，螺纹圆柱外形，PTFE涂层，直流三线输出，耐酸碱腐蚀，抗火花喷溅，抗干扰优化，IP67防护等级，高亮LED指示灯。

### 参数:

型号	额定工作距离	安装方式	输出	电源电压	额定电流	开关频率	环境温度	接线方式	机械图
Fi2A-TM08-OP6L	2mm	齐平	PNP NO	10...30VDC	≤200mA	1000Hz	-25...70℃	2米电缆	图1
Fi2A-TM08-ON6L	2mm	齐平	NPN NO	10...30VDC	≤200mA	1000Hz	-25...70℃	2米电缆	图1
Fi2A-TM08-CP6L	2mm	齐平	PNP NC	10...30VDC	≤200mA	1000Hz	-25...70℃	2米电缆	图1
Fi2A-TM08-CN6L	2mm	齐平	NPN NC	10...30VDC	≤200mA	1000Hz	-25...70℃	2米电缆	图1
Fi2A-TM08-OP6L-Q12	2mm	齐平	PNP NO	10...30VDC	≤200mA	1000Hz	-25...70℃	M12连接器	图2
Fi2A-TM08-ON6L-Q12	2mm	齐平	NPN NO	10...30VDC	≤200mA	1000Hz	-25...70℃	M12连接器	图2
Fi2A-TM08-CP6L-Q12	2mm	齐平	PNP NC	10...30VDC	≤200mA	1000Hz	-25...70℃	M12连接器	图2
Fi2A-TM08-CN6L-Q12	2mm	齐平	NPN NC	10...30VDC	≤200mA	1000Hz	-25...70℃	M12连接器	图2
Fi3A-TM12-OP6L	3mm	齐平	PNP NO	10...30VDC	≤200mA	1000Hz	-25...70℃	2米电缆	图3
Fi3A-TM12-ON6L	3mm	齐平	NPN NO	10...30VDC	≤200mA	1000Hz	-25...70℃	2米电缆	图3
Fi3A-TM12-CP6L	3mm	齐平	PNP NC	10...30VDC	≤200mA	1000Hz	-25...70℃	2米电缆	图3
Fi3A-TM12-CN6L	3mm	齐平	NPN NC	10...30VDC	≤200mA	1000Hz	-25...70℃	2米电缆	图3
Fi3A-TM12-OP6L-Q12	3mm	齐平	PNP NO	10...30VDC	≤200mA	1000Hz	-25...70℃	M12连接器	图4
Fi3A-TM12-ON6L-Q12	3mm	齐平	NPN NO	10...30VDC	≤200mA	1000Hz	-25...70℃	M12连接器	图4
Fi3A-TM12-CP6L-Q12	3mm	齐平	PNP NC	10...30VDC	≤200mA	1000Hz	-25...70℃	M12连接器	图4
Fi3A-TM12-CN6L-Q12	3mm	齐平	NPN NC	10...30VDC	≤200mA	1000Hz	-25...70℃	M12连接器	图4

### 机械图:

图1



图2



图3

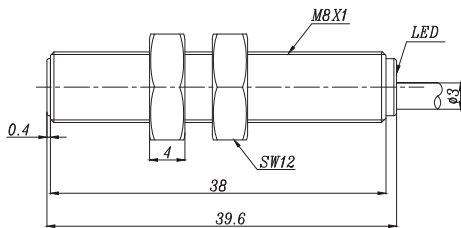

图4

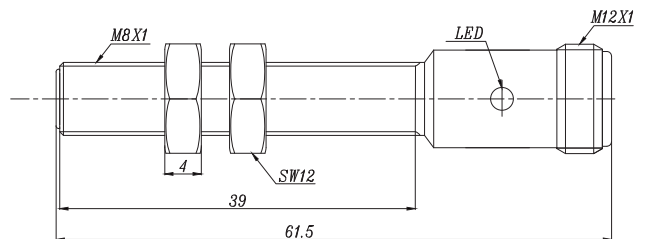

## 特氟龙涂层型

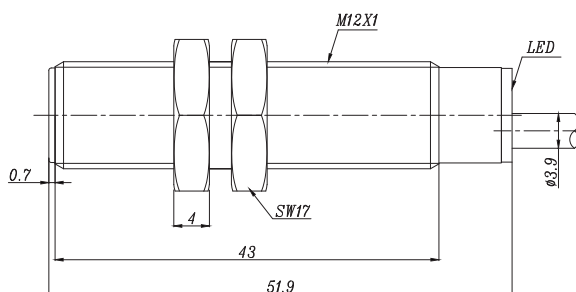
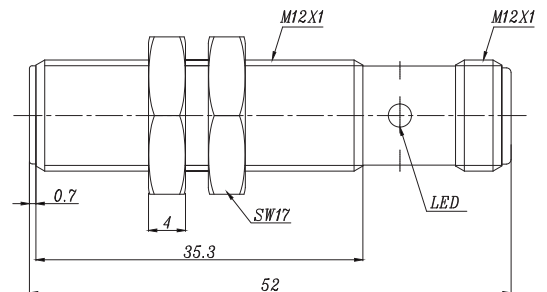

### 产品说明:

金属外壳，螺纹圆柱外形，PTFE涂层，直流三线输出，耐酸碱腐蚀，抗火花喷溅，抗干扰优化，IP67防护等级，高亮LED指示灯。

### 参数:

型号	额定工作距离	安装方式	输出	电源电压	额定电流	开关频率	环境温度	接线方式	机械图
Fi5A-TM18-OP6L	5mm	齐平	PNP NO	10...30VDC	≤200mA	800Hz	-25...70℃	2米电缆	图1
Fi5A-TM18-ON6L	5mm	齐平	NPN NO	10...30VDC	≤200mA	800Hz	-25...70℃	2米电缆	图1
Fi5A-TM18-CP6L	5mm	齐平	PNP NC	10...30VDC	≤200mA	800Hz	-25...70℃	2米电缆	图1
Fi5A-TM18-CN6L	5mm	齐平	NPN NC	10...30VDC	≤200mA	800Hz	-25...70℃	2米电缆	图1
Fi5A-TM18-OP6L-Q12	5mm	齐平	PNP NO	10...30VDC	≤200mA	800Hz	-25...70℃	M12连接器	图2
Fi5A-TM18-ON6L-Q12	5mm	齐平	NPN NO	10...30VDC	≤200mA	800Hz	-25...70℃	M12连接器	图2
Fi5A-TM18-CP6L-Q12	5mm	齐平	PNP NC	10...30VDC	≤200mA	800Hz	-25...70℃	M12连接器	图2
Fi5A-TM18-CN6L-Q12	5mm	齐平	NPN NC	10...30VDC	≤200mA	800Hz	-25...70℃	M12连接器	图2
Fi10A-TM30-OP6L	10mm	齐平	PNP NO	10...30VDC	≤200mA	400Hz	-25...70℃	2米电缆	图3
Fi10A-TM30-ON6L	10mm	齐平	NPN NO	10...30VDC	≤200mA	400Hz	-25...70℃	2米电缆	图3
Fi10A-TM30-CP6L	10mm	齐平	PNP NC	10...30VDC	≤200mA	400Hz	-25...70℃	2米电缆	图3
Fi10A-TM30-CN6L	10mm	齐平	NPN NC	10...30VDC	≤200mA	400Hz	-25...70℃	2米电缆	图3
Fi10A-TM30-OP6L-Q12	10mm	齐平	PNP NO	10...30VDC	≤200mA	400Hz	-25...70℃	M12连接器	图4
Fi10A-TM30-ON6L-Q12	10mm	齐平	NPN NO	10...30VDC	≤200mA	400Hz	-25...70℃	M12连接器	图4
Fi10A-TM30-CP6L-Q12	10mm	齐平	PNP NC	10...30VDC	≤200mA	400Hz	-25...70℃	M12连接器	图4
Fi10A-TM30-CN6L-Q12	10mm	齐平	NPN NC	10...30VDC	≤200mA	400Hz	-25...70℃	M12连接器	图4

### 机械图:

图1



图2



图3

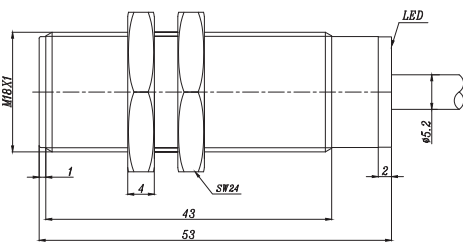

图4

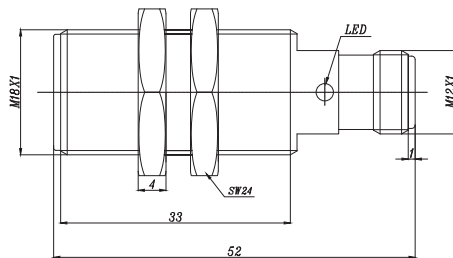
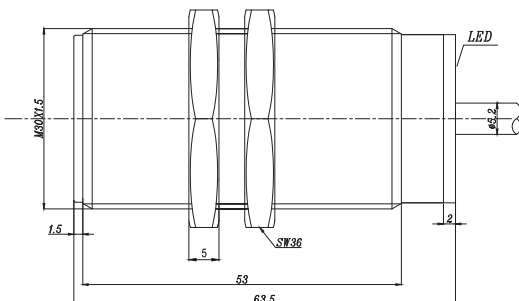