

DeviceNet 总线附件——双端总线预铸电缆

- Micro-Change至Micro-Change
- Micro-Change（孔）至Mini-Change（针）



双端预铸

示意图

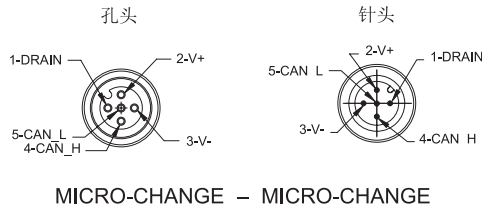

孔头/针头	FIG	双端预铸 细缆
直/直	1	DND22A-Mxxx
90°/直	2	DND32A-Mxxx
直/90°	3	DND23A-Mxxx
90°/90°	4	DND33A-Mxxx

示意图

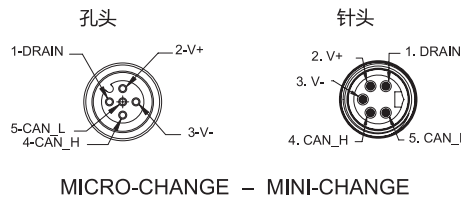

孔头 MICRO-CHANGE/ 针头MINI-CHANGE	FIG	双端预铸 细缆
直/直	5	DND21A-Mxxx
90°/直	6	DND31A-Mxxx
直/90°	7	DND29A-Mxxx
90°/90°	8	DND39A-Mxxx

型号说明

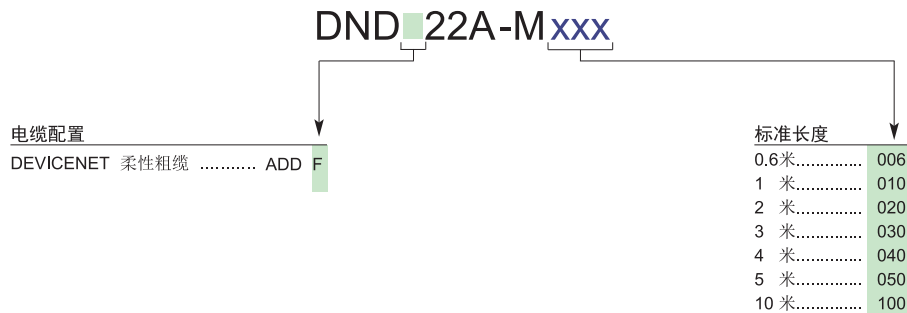

自动化连接器

DeviceNet 总线附件——双端总线预铸电缆

尺寸图

FIG 1

孔直 Micro-Change / 针直 Micro-Change

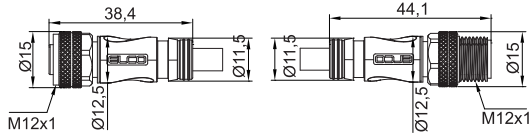

FIG 2

孔 90° Micro-Change / 针直 Micro-Change

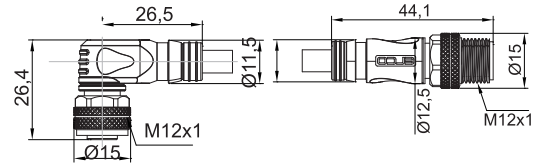

FIG 3

孔直 Micro-Change / 针 90° Micro-Change

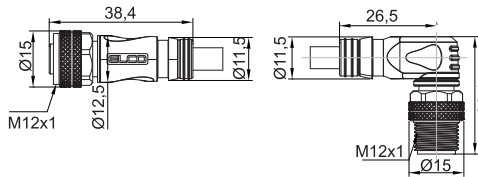

FIG 4

孔 90° Micro-Change / 针 90° Micro-Change

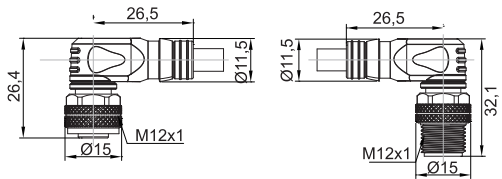

FIG 5

孔直 Micro-Change / 针直 Mini-Change

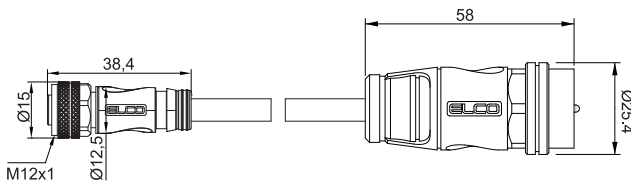

FIG 6

孔 90° Micro-Change / 针直 Mini-Change

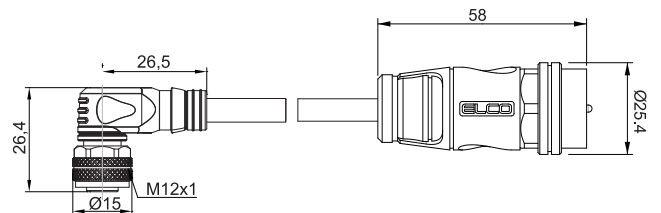

FIG 7

孔直 Micro-Change / 针 90° Mini-Change

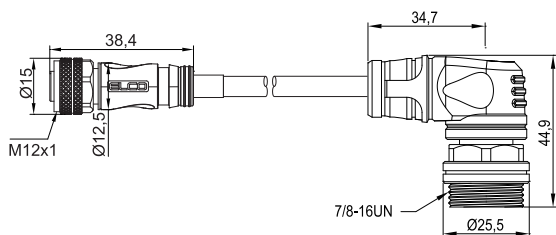
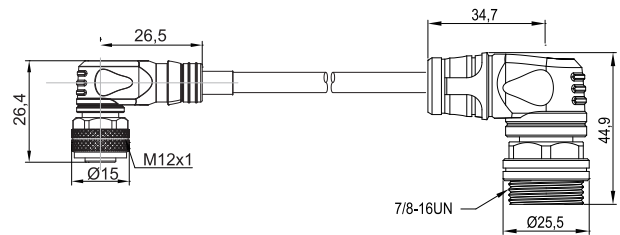

FIG 8

孔 90° Micro-Change / 针 90° Mini-Change



DeviceNet 总线附件——双端总线预铸电缆

■ Mini-Change (孔) 至 Micro-Change (针)



双端预铸

示意图

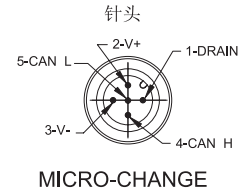
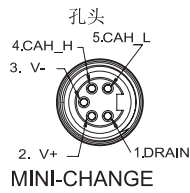

孔 (MINI-CHANGE) / 针 (MICRO-CHANGE)

双端预铸 细缆

直/直	1	DND12A-Mxxx
直/90°	2	DND13A-Mxxx
90°/直	3	DND92A-Mxxx
90°/90°	4	DND93A-Mxxx

型号说明

DND 12A-Mxxx

电缆配置

DEVICENET 柔性细缆 ADD F

标准长度

0.6米.....	006
1 米.....	010
2 米.....	020
3 米.....	030
4 米.....	040
5 米.....	050
10 米.....	100

尺寸图

FIG 1

孔直 Mini-Change / 针直 Micro-Change

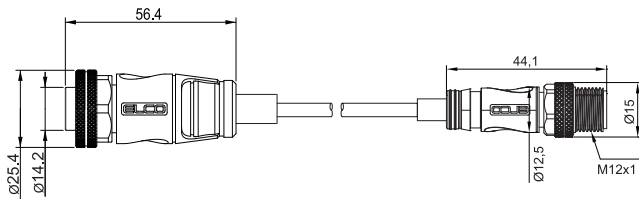

FIG 2

孔 90° Mini-Change / 针直 Micro-Change

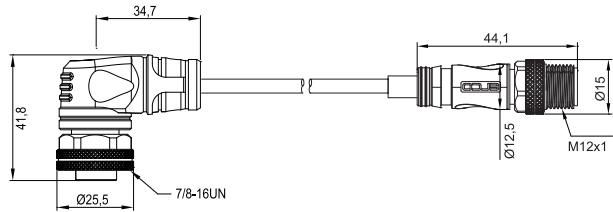

FIG 3

孔直 Mini-Change / 针 90° Micro-Change

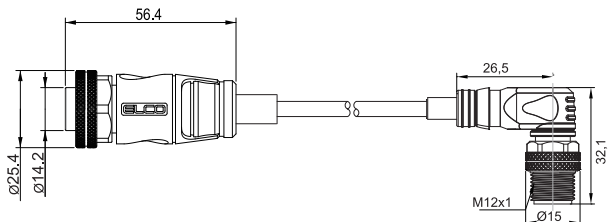

FIG 4

孔 90° Mini-Change / 针 90° Micro-Change

